

LaboForce-100

Instruction Manual

Original Instructions



CE

Doc. no.: 16367025-05_A_en-us
Date of release: 2023.02.27

Copyright

The contents of this manual are the property of Struers ApS. Reproduction of any part of this manual without the written permission of Struers ApS is not allowed.

All rights reserved. © Struers ApS 2023.02.27.

Table of Contents

1	About this manual	5
2	Safety	5
2.1	Intended use	5
2.2	LaboForce-100 safety precautions	5
2.2.1	Read carefully before use	5
2.3	Safety messages	6
2.4	Safety messages in this manual	7
3	Getting started	8
3.1	Device description	8
3.2	LaboForce-100	8
4	Transport and storage	9
4.1	Long-term storage or shipping	9
5	Installation	9
5.1	Unpack the machine	9
5.2	Check the packing list	9
5.3	Installation - LaboForce-100	10
5.4	Electrical connection to the machine	10
5.5	Compressed-air connections	11
5.6	The specimen mover	11
5.6.1	Insert a specimen holder	11
5.6.2	Insert a specimen mover plate	12
5.6.3	Adjust the height of the specimen mover plate	12
5.6.4	Adjust the horizontal position of the specimen holder or specimen mover plate	14
5.6.5	Complete the adjustment	15
5.7	The flexible specimen holder	15
5.7.1	Adjust the height of the flexible specimen holder	17
5.7.2	Adjust the horizontal position of the flexible specimen holder	17
5.8	LaboDoser-100 with LaboForce-100	18
5.9	LaboDoser-10 with LaboForce-100	18
5.10	Noise and vibration levels	18
6	Operate the device	18
6.1	Control panel functions	18

7	Maintenance and service	20
7.1	General cleaning	20
7.2	Daily	21
7.3	Weekly	21
7.3.1	LaboForce-100 - the specimen mover head	21
7.4	Monthly	22
7.4.1	LaboForce-100 - Empty the water/oil filter	22
7.5	Spare parts	22
7.6	Service and repair	22
7.6.1	Service check - LaboForce-100	23
7.7	Disposal	23
8	Troubleshooting	24
8.1	LaboForce-100	24
8.1.1	Messages and errors - LaboForce-100	24
9	Technical data	27
9.1	Technical data - LaboForce-100	27
9.2	Diagrams - LaboForce-100	28
9.3	Legal and regulatory information	31
10	Manufacturer	31
	Declaration of Incorporation of Partly Completed Machinery	33

1 About this manual



CAUTION

Struers equipment must only be used in connection with and as described in the Instruction Manual supplied with the equipment.



Note

Read the Instruction Manual carefully before use.



Note

If you wish to view specific information in detail, see the online version of this manual.

2 Safety

2.1 Intended use

The device is for professional semi-automatic materialographic preparation (grinding or polishing) of materials for further materialographic inspection.

LaboForce-100 is intended to be used in combination with:

- LaboPol-30
- LaboPol-60
- LaboDoser-100

Do not use the device for the following Other equipment than stated in the section "Intended use".

Model LaboForce-100

2.2 LaboForce-100 safety precautions



2.2.1 Read carefully before use

Ignoring this information and mishandling of the equipment can lead to severe bodily injuries and material damage.

Specific safety precautions - residual risks

1. To prevent specimens from detaching from the specimen holder, make sure that the specimen or specimens are clamped securely in the specimen holder.
2. Protective footwear is recommended when you handle heavy specimen holders.

General safety precautions

1. The machine must be installed in compliance with local safety regulations. All functions on the machine and any connected equipment must be in working order.
2. This device must be mounted securely on the machine.
3. The operator must read the safety precautions and Instruction Manual, as well as relevant sections of the manuals for any connected equipment and accessories.
4. If you observe malfunctions or hear unusual noises, switch off the machine and call technical service.
5. Consumables: only use consumables specifically developed for use with this type of materialographic machine. Alcohol-based consumables: follow the current safety rules for handling, mixing, filling, emptying and disposing of alcohol-based liquids.
6. In case of fire, alert bystanders and the fire brigade. Disconnect the electrical power supply. Use a powder fire extinguisher. Do not use water.
7. This machine must be operated and maintained only by skilled/trained personnel.
8. Always switch off the electrical power supply and remove the plug or power cable before dismantling the machine or installing additional components.
9. The machine must be disconnected from the electrical power supply before any service. Wait 5 minutes until residual potential on the capacitors is discharged.
10. Struers equipment must only be used in connection with and as described in the Instruction Manual supplied with the equipment.
11. The equipment is designed to be used only with Struers consumables specifically designed for this purpose and this type of machine.
12. If the equipment is subjected to misuse, incorrect installation, alteration, neglect, accident or incorrect repair, Struers will accept no responsibility for damage to the user or the equipment.
13. Dismantling of any part of the equipment, during service or repair, should always be performed by a qualified technician (electromechanical, electronic, mechanical, pneumatic, etc.).

2.3 Safety messages

Struers uses the following signs to indicate potential hazards.



ELECTRICAL HAZARD

This sign indicates an electrical hazard which, if not avoided, will result in death or serious injury.

**DANGER**

This sign indicates a hazard with a high level of risk which, if not avoided, will result in death or serious injury.

**WARNING**

This sign indicates a hazard with a medium level of risk which, if not avoided, could result in death or serious injury.

**CAUTION**

This sign indicates a hazard with a low level of risk which, if not avoided, could result in minor or moderate injury.

**CRUSHING HAZARD**

This sign indicates a crushing hazard which, if not avoided, could result in minor, moderate or serious injury.

**HEAT HAZARD**

This sign indicates a heat hazard which, if not avoided, can result in minor, moderate or serious injury.

General messages**Note**

This sign indicates that there is a risk of damage to property, or a need to proceed with special care.

**Hint**

This sign indicates that additional information and hints are available.

2.4 Safety messages in this manual**WARNING**

Struers equipment must only be used in connection with and as described in the Instruction Manual supplied with the equipment.

**CRUSHING HAZARD**

Wear safety shoes when handling heavy machinery.

3 Getting started

3.1 Device description

LaboForce-100 is a control panel/specimen mover unit which can be mounted on the following machines for semi-automatic materialographic preparation (grinding/polishing): LaboPol-30 and LaboPol-60.

On the control panel screen the operator sets up the process parameters required, the grinding/polishing surface and the cooling fluid/abrasive suspension to be applied.

Cooling water is applied automatically when the operator opens the water tap. The operator applies other fluids manually, or automatically if LaboDoser-100 is installed.

A holding device for the preparation of specimens must be used with the specimen mover. The holding device holds a maximum of 6 specimens.

The operator decides which holding device should be used:

- A specimen holder, which is a fixture that secures the specimens.
- A specimen mover plate, where pressurized feet from the mover head keep the specimens in place.

The operator starts the machine by pressing the Start button on the control panel.

The machine stops automatically.

The operator cleans the specimens before the next preparation step or inspection.

The machine must always be used with the splash guard in place.

If the emergency stop is activated, the power to all moving parts is cut.

3.2 LaboForce-100

Front view

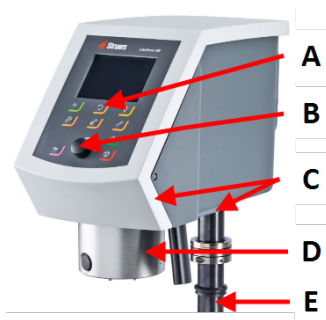

- A Control panel
- B Turn/push knob
- C LED lights (not shown)
- D Specimen mover head
- E Control panel column

4 Transport and storage

If, at any time after the installation, you have to move the unit or place it in storage, there is a number of guidelines we recommend that you follow.

- Package the unit securely before transportation. Insufficient packaging could cause damage to the unit and will void the warranty. Contact Struers Service.
- We recommend that you use the original packaging and fittings.

4.1 Long-term storage or shipping

For instructions on how to prepare the unit for long-term storage or shipping, see the specific machine manual.

Pay specific attention to the following:

- Disconnect the unit from the electrical power supply.
- Remove the control panel or specimen mover.
- Place the machine and accessories in their original packaging.

5 Installation

5.1 Unpack the machine



Note

We recommend that you keep all original packaging and fittings for future use.

1. Cut the packing tape on the top of the box.
2. Remove the loose parts.
3. Remove the unit from the box.

5.2 Check the packing list

Optional accessories may be included in the packing box.

The packing box contains the following items:

Pcs.	Description
1	LaboForce-100
1	Connection piece. Diameter: 6 to 1/8"
1	Allen key with cross handle, 4 x 150

Pcs.	Description
1	Spacing disc
1	Distance piece, to be used with flexible specimen holders
1	Instruction Manual set

5.3 Installation - LaboForce-100

Note
This device must be mounted securely on the machine.

Note
Do not use the Turn/push knob knob to move LaboForce-100.

Procedure

1. Install the specimen mover in the support hole of the machine.
2. Use the Allen key to tighten the two fastening screws. Do not tighten the screws completely.

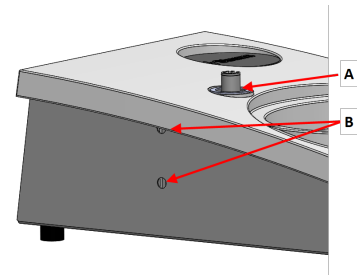

A Support hole
B Fastening screws

5.4 Electrical connection to the machine

Hint
The communication cable in the support hole is not used for LaboForce-100.

The cable attached to LaboForce-100 provides a 24 V power supply and a data bus, which enables the machine and LaboForce-100 to communicate.

1. Switch off the machine.
2. Connect the cable to the LaboForce-100 connector on the back of the machine.

5.5 Compressed-air connections

Procedure



Note

The main air valve is not a part of the unit and must be installed and set before the specimen mover is installed.

1. Fit the quick coupling on the compressed air hose and secure it with the hose clamp.
2. Connect the air inlet hose to the quick coupling.
3. Fit the other end of the air inlet hose into the compressed air inlet on the specimen mover.



Note

The air pressure must be between 6 bar (87 psi) and 9.9 bar (143 psi).



Hint

The specimen mover requires a continuous flow of compressed air through the regulator valve – a faint hissing sound does not mean that there is an air leak.

5.6 The specimen mover

The specimen mover can be used with specimen mover plates for single specimens or specimen holders for multiple specimens.

5.6.1 Insert a specimen holder

Insert a specimen holder



CAUTION

To prevent specimens from detaching from the specimen holder, make sure that the specimen or specimens are clamped securely in the specimen holder.



CAUTION

Protective footwear is recommended when you handle heavy specimen holders.



CRUSHING HAZARD

Keep your hands clear of the specimen holder or specimen mover plate when lowering the specimen mover.



Note

When you work with specimen holders, make sure that the screws clamping the specimens do not stick out of the specimen holder.
Use different lengths of screws for specimens with different diameters.

**Hint**

The maximum height of specimens in the specimen holder is 32 mm. If the specimens exceed 32 mm, the specimen holder cannot be placed in the specimen mover head.

1. Press the **Lower/Raise** button to make sure that the specimen mover head is fully raised.
2. Press the black button on the specimen mover head.
3. Insert the specimen holder and rotate it until the three pins are aligned with the holes in the specimen mover.
4. Push the specimen holder upwards until it locks into position.
5. Release the black button on the specimen mover head. Make sure that the specimen holder is securely fixed.

**Hint**

If you use a specimen holder, you do not need to adjust the height.

5.6.2 Insert a specimen mover plate

1. Press the **Lower/Raise** button to make sure that the specimen mover head is fully raised.
2. Press the black button on the specimen mover head.
3. Insert the specimen mover plate and rotate it until the three pins are aligned with the holes in the specimen mover.
4. Push the specimen mover plate upwards until it locks in position.
5. Release the black button on the specimen mover head. Make sure that the specimen mover plate is securely fixed.



5.6.3 Adjust the height of the specimen mover plate

The following applies only when specimen mover plates are used.

1. With a specimen mover plate mounted, place a preparation surface on the preparation disc.
2. Select the 'thickest' preparation surface to be used and place it on the preparation disc. Usually, this will be SiC Foil on an MD-Gekko disc, or SiC Paper on an MD-Fuga disc, or an MD-Alto.
3. Place the supplied spacing disc on the preparation surface.

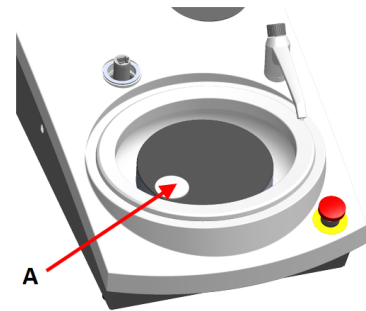

A Spacing disc

4. Support the LaboForce-100 head and loosen the screw in the adjustment ring.

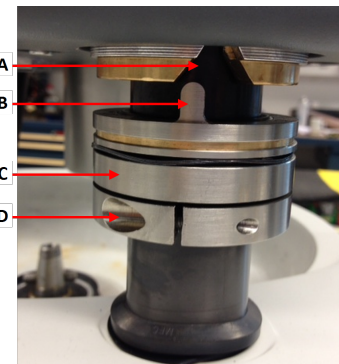

A V-shaped groove
B Pin
C Adjustment ring
D Fastening screw

5. Press the **Lower/Raise** button to lower the specimen mover head. An error message will appear as the specimen mover head is not in contact with the adjustment ring.



6. Move the adjustment ring up until the pin fits into the V-shaped groove on the cabinet of the control panel.
7. Tighten the adjustment ring to fix it in this position.
8. Press the **Turn/push knob** knob to clear the error message.
9. Press the **Lower/Raise** button to raise the specimen mover head.



5.6.4 Adjust the horizontal position of the specimen holder or specimen mover plate

With a specimen holder or specimen mover plate mounted:

1. Press the **Lower/Raise** button to lower the specimen mover head.
2. Loosen the 2 fastening screws holding the column of the control panel.
3. Replace the manual splash guard with a splash guard for semi-automatic preparation or splash guard for Wet grinding disc.
4. Moves the specimen mover head to the right.



With an MD-disc

1. Place the specimen mover plate in a position that allows the specimen to run 3 – 4 mm over the edge of the preparation disc.

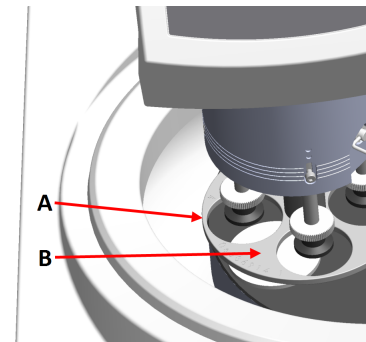

- A Disc edge
- B Specimen mover plate

With a Wet grinding disc

1. Place the specimen mover plate in a position 2 – 3 mm from the metal ring.



Note

The column can only be turned slightly.
Do not force it.

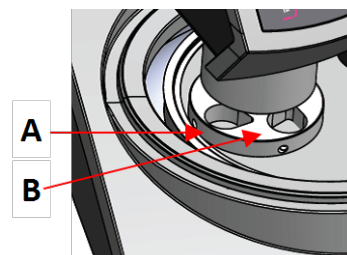

- A Metal ring
- B Specimen holder

5.6.5 Complete the adjustment

1. Tighten the 2 fastening screws firmly. The specimen mover will now remain in position.
2. Cover the holes with the two caps.

Allen key and cover caps are included in the package.

5.7 The flexible specimen holder

1. From the **Main menu** screen select **Flexible specimen holder methods**.
2. If the menu item **Flexible specimen holder methods** is not available in the main menu, you must activate it in the software:
 - In the **Configuration** menu, select **Options**.
 - Set **Flexible specimen holder** to **Yes**.

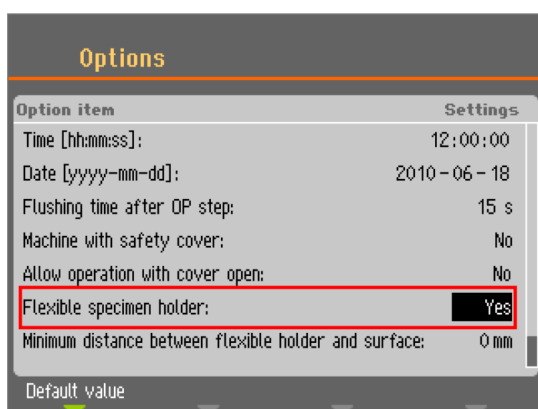

Insert a flexible specimen holder



CAUTION

To prevent specimens from detaching from the specimen holder, make sure that the specimen or specimens are covered completely by the flexible specimen holder.



CRUSHING HAZARD

Keep your hands clear of the flexible specimen holder when lowering the specimen mover.

Procedure



Hint

Make sure that you use sufficient force according to the specimen size and Struers recommendations.

The Struers Metalog Guide methods are based on a specimen with an area of 7 cm². Adjust the method according to your specific specimen area.



Hint

Make sure that the preparation surface is sufficiently wet before you start the preparation process.

1. Press the **Lower/Raise** button to make sure that the specimen mover head is fully raised.
2. Press the black button on the specimen mover head.
3. Insert the flexible specimen holder and rotate it until the three pins are aligned with the holes in the specimen mover.
4. Push the flexible specimen holder upwards until it locks into position.
5. Release the black button on the specimen mover head. Make sure that the flexible specimen holder is securely fixed.



Use the flexible specimen holder

1. Place the specimen or specimens on the preparation surface.
2. Press the **Lower/Raise** button to lower the flexible specimen holder.
3. Make sure that no specimens protrude from the flexible specimen holder. If they do, adjust the specimens.
 - Press the **Lower/Raise** button to raise the flexible specimen holder.
 - Adjust the specimens.
4. Repeat until all specimens are placed correctly.
5. Start the preparation process.

The preparation process stops automatically when the set preparation time has expired.
6. Clean the flexible specimen holder before the next preparation step.



5.7.1 Adjust the height of the flexible specimen holder

Procedure

- 1.
2. Attach the distance piece as shown in the illustration below.

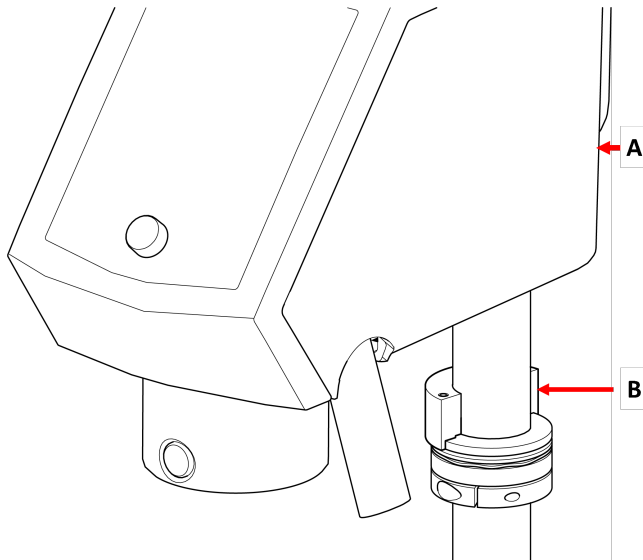

- A LaboForce-100
- B Distance piece

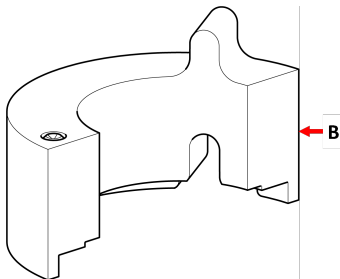

- B Distance piece



Note

Make sure to remove the distance piece if you are going to work with mover plates or regular specimen holders again.

5.7.2 Adjust the horizontal position of the flexible specimen holder

With a flexible specimen holder:

1. Press the **Lower/Raise** button to lower the specimen mover head.
2. Loosen the 2 fastening screws holding the column of the control panel.
3. Place the flexible specimen holder in a position that does not allow the specimen to run more than 1 mm over the edge of the preparation disc.



5.8 LaboDoser-100 with LaboForce-100

If you are using LaboDoser-100 with LaboForce-100, see the specific machine manual.

5.9 LaboDoser-10 with LaboForce-100

If you are using LaboDoser-10 with LaboForce-100, a table stand is required.



5.10 Noise and vibration levels

For information about noise and vibration levels, see the specific machine manual.

6 Operate the device

For instructions on how to operate the device, see the specific machine manual.

See also the section "Intended use" for the specific machine manual.

6.1 Control panel functions



CAUTION





Keep clear of rotating parts during operation.

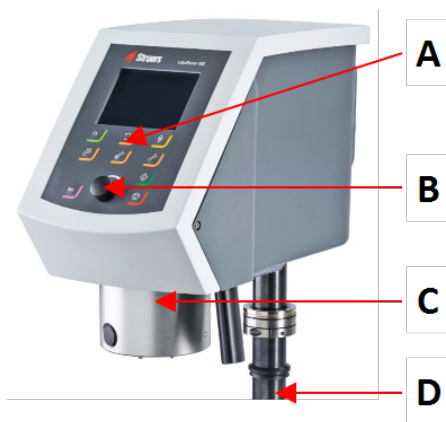



**CAUTION**

When working at machines with rotating parts, take care to prevent clothes and/or hair from being caught by the rotating parts.



- A Control panel
- B Turn/push knob knob
- C Specimen mover head
- D Control panel column

Button	Function
	<p>Function key</p> <ul style="list-style-type: none"> Press this button to activate controls for various purposes. See the bottom line of the individual screens.
	<p>Disc rotation</p> <ul style="list-style-type: none"> Starts rotation of the disc (Spin function). Press this button again to stop the rotation.
	<p>Lower/Raise</p> <p>Press this button to lowers and raise the specimen mover head when preparing single specimens or when adjusting positions of the specimen mover plate or specimen holder.</p>
	<p>Water</p> <p>Manual override</p> <ul style="list-style-type: none"> Press the button to apply water. Water is applied when no process is running. Press the button again to stop applying water. Water switches off automatically after 5 minutes.
	<p>Abrasive</p> <p>This function is only active when dosing units are installed.</p> <ul style="list-style-type: none"> Manual override: Press this button to apply diamond suspension from the doser bottle.

Button	Function
	<p>Lubricant</p> <p>This function is only active when dosing units are installed.</p> <ul style="list-style-type: none"> Manual override: Press this button to apply lubricant from the doser bottle.
	<p>Start</p> <ul style="list-style-type: none"> Starts the preparation process.
	<p>Stop</p> <ul style="list-style-type: none"> Stops the preparation process.
	<p>Escape</p> <ul style="list-style-type: none"> Press this button to return to the previous screen or to cancel functions/changes.

 <p>A Turn/push knob knob</p>	<p>The Turn/push knob knob</p> <ul style="list-style-type: none"> Turn the Turn/push knob knob to move the focus on the screen and change steps and setting. Press to toggle when only 2 options are available. Press the Turn/push knob knob to select a function or save a selected setting.
--	---

7 Maintenance and service

Technical questions and spare parts

If you have technical questions or when you order spare parts, state serial number and voltage/frequency. The serial number and the voltage are stated on the type plate of the machine.

7.1 General cleaning

To ensure a longer lifetime for your machine, we strongly recommends regular cleaning.



Note
Do not use a dry cloth as the surfaces are not scratch resistant.

**Note**

Do not use acetone, benzol or similar solvents.

If the machine is not to be used for a longer period of time

- Clean the machine and all accessories thoroughly.

7.2 Daily

- Clean all accessible surfaces with a soft, damp cloth.

7.3 Weekly

- Clean the control panel with a soft damp cloth and common household detergents.

7.3.1 LaboForce-100 - the specimen mover head**Cleaning**

LaboForce-100 is equipped with a function for cleaning the feet that apply the force on the specimens and also for cleaning the lock that secures the specimen mover plate for single specimens.

The force on the pressure feet is generated by friction pins held in place by the screws in the spring housing.

Clean the pressure feet and pistons applying the force on the specimens and specimen holder.

Procedure

1. Press the release outlet valve to drain the water/oil filter. See the section [LaboForce-100 - Empty the water/oil filter ▶ 22](#).
2. From the **Main menu** select **Maintenance > Cleaning of specimen mover head**.
3. Press **F1** to activate one of the functions shown.

**Note**

Never force any of the movements. If the components do not move as they should, contact Struers Service.

- | | |
|--|--|
| <ul style="list-style-type: none"> – Lower feet – Raise feet | <p>The pistons can be cleaned or lubricated.</p> <p>Moves the feet back into operating position.</p> |
|--|--|

- | | |
|---------------|---|
| – Holder up | Moves the specimen mover head up for cleaning. |
| – Holder down | Moves the specimen mover head back into operating position. |

7.4 Monthly

7.4.1 LaboForce-100 - Empty the water/oil filter

The specimen mover is fitted with a water/oil filter that removes excessive amounts of water and oil from the compressed air supply.

The filter must be emptied on a regular basis.

Procedure

1. Locate the release outlet valve at the bottom of LaboForce-100.
2. Hold a cloth under the release outlet valve and press the valve to empty the water/oil filter.



7.5 Spare parts

For specific safety related parts, see the section "Safety Related Parts of the Control System (SRP/CS)" in the section "Technical data" in this manual.

Technical questions and spare parts

If you have technical questions or when you order spare parts, state serial number and voltage/frequency. The serial number and the voltage are stated on the type plate of the machine.

For further information, or to check the availability of spare parts, contact Struers Service. Contact information is available on [Struers.com](https://www.struers.com).

7.6 Service and repair

We recommend that a regular service check be carried out yearly or after every 1500 hours of use.

When the machine is started up, the display shows information about total operation time and the machines service information.

After 1500 hours of operation time, the display will show a message reminding the user that a service check should be scheduled.

**Note**

Service must only be performed by a qualified technician (electromechanical, electronic, mechanical, pneumatic, etc.).
Contact Struers Service.

7.6.1 Service check - LaboForce-100

Information about total operation time and servicing of the machine is displayed on the screen at start-up.

After 1,500 hours of operation time, a pop-up message will appear to alert the operator that the recommended service interval has been exceeded.

- Contact Struers Service.

Service information

LaboForce-100 provides extensive information about the condition of the various components.

**Hint**

The service information menus and screens are in English only.
Use the names and terms shown on the screen when you communicate with your local service technician or Struers Service.

Service information is read-only information. Machine settings cannot be changed or modified.

- From the **Main menu** select **Maintenance > Service functions**.

In the **Service functions** screen you can access a number of screens:

- **Device information**
- **Statistics**
- **Inputs**
- **Outputs**
- **Voltage and temperature monitor**
- **Functional tests**
- **Adjustment and calibration**

Service information can be used in cooperation with Struers Service for remote diagnostics of the equipment.

7.7 Disposal



Equipment marked with a WEEE symbol contains electrical and electronic components and must not be disposed of as general waste.

Contact your local authorities for information on the correct method of disposal in accordance with national legislation.

For disposal of consumables and recirculation fluid, follow local regulations.

8 Troubleshooting

For troubleshooting guidance, see the specific machine manual.

8.1 LaboForce-100

Error	Cause	Action
Specimen holder plate vibrates.	Specimen holder plate unbalanced.	Replace specimen holder plate.
	Specimen holder plate screws loose.	Tighten specimen holder plate screws.
The preparation disc runs unevenly or stops.	Force too high.	Reduce the force.
The preparation disc stops.	Frequency inverter has stopped the equipment.	Switch the equipment off. Wait for a few minutes then Re-start. If the error remains: Contact Struers Service.
The column starts to turn.	Column screws loose.	Tighten the screws immediately.
Uneven specimens.	Specimens are wider than the radius of the preparation disc.	Use smaller specimens.
	Specimens are passing over the center of the disc.	Reposition the horizontal position of the control panel.
Continuous, irregular wear on a grinding/polishing surface.	Coupling on the specimen holder is worn.	Replace the coupling.

8.1.1 Messages and errors - LaboForce-100

Error messages are divided into two classes:

- Messages and errors





Messages

Messages provide information about the machine's status and minor errors.

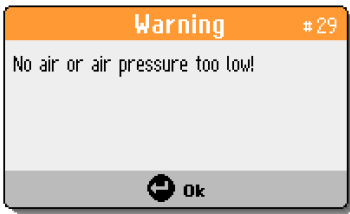

Errors

Errors must be corrected before operation can be continued.

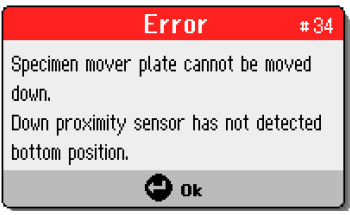
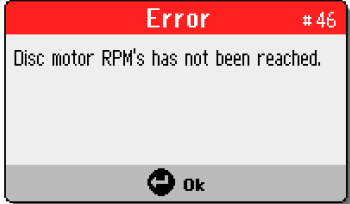
Press **Enter** to acknowledge the error/message.

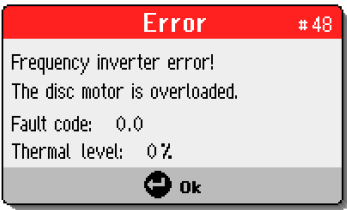
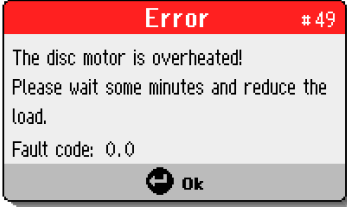
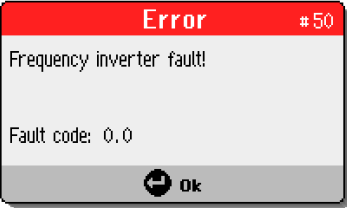
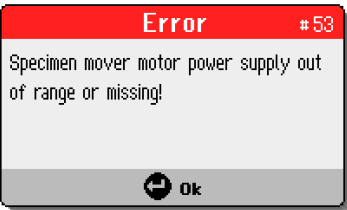
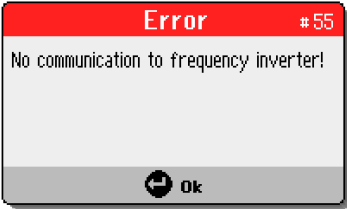
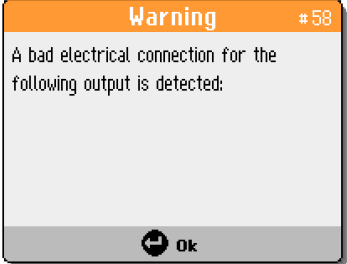
#	Error Message	Explanation	Action
3	 <p>Fatal error #3 Machine failed during Power On Self Testing. Please reboot the machine. If the problem persists please contact Struers technical support Reason: #_ - Unknown error Ok</p>	Failure of internal communication on start-up.	Restart the machine. If the error remains, contact Struers Service. Make a note of the Reason number.
28	 <p>Error #28 Specimen holder cannot be moved down. Down proximity sensor has not detected bottom position. Ok</p>		Make sure that there are no obstacles preventing the movement of the specimen holder. Check the pneumatic system. If the error remains, contact Struers Service.
29	 <p>Warning #29 No air or air pressure too low! Ok</p>	Pressure of the compressed air supply is too low.	Check the compressed air supply.
30	 <p>Error #30 Pressure regulating error! Ok</p>	Pressure of the compressed air supply is too high/low.	Check the compressed air supply. Restart the machine. If the error remains, contact Struers Service.
34	 <p>Error #34 Specimen mover plate cannot be moved down. Down proximity sensor has not detected bottom position. Ok</p>		Make sure that there are no obstacles preventing the movement of the specimen mover plate. Check the pneumatic system. If the error remains, contact Struers Service.
46	 <p>Error #46 Disc motor RPM's has not been reached. Ok</p>	Disc motor will not rotate or cannot reach the set rpm. Polishing process is paused.	Restart the process. If the error remains, contact Struers Service.

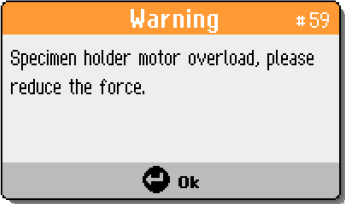
#	Error Message	Explanation	Action
48	 <p>Error #48 Frequency inverter error! The disc motor is overloaded. Fault code: 0,0 Thermal level: 0% OK</p>		Wait for the disc motor to cool. Reduce the force and continue the preparation process.
49	 <p>Error #49 The disc motor is overheated! Please wait some minutes and reduce the load. Fault code: 0,0 OK</p>		Wait for the disc motor to cool. Reduce the force and continue the preparation process.
50	 <p>Error #50 Frequency inverter fault! Fault code: 0,0 OK</p>	An error in the frequency inverter is detected.	Restart the machine. If the error remains, contact Struers Service. Please make a note of the Fault code.
53	 <p>Error #53 Specimen mover motor power supply out of range or missing! OK</p>		Restart the machine. If the error remains, contact Struers Service.
55	 <p>Error #55 No communication to frequency inverter! OK</p>		Restart the machine. If the error remains, contact Struers Service.
58	 <p>Warning #58 A bad electrical connection for the following output is detected: OK</p>		Restart the machine. Make a note of the output. If the error remains, contact Struers Service.

#	Error Message	Explanation	Action
59			<p>Reduce the force or/and increase the specimen rpms.</p> <p>Restart the process.</p> <p>If the error remains, contact Struers Service.</p>
26		<p>The pneumatic head with specimen mover plate is not down when the process is started.</p> <p>Appears if method is started in single specimen mode (SS) and mover plate is not lowered.</p>	<p>Lower the pneumatic head.</p> <p>Restart the process.</p>

9 Technical data

9.1 Technical data - LaboForce-100

Subject	Specifications	
	Motor output	180 W
	Rotational speed	50-150 rpm
	Rotational direction	Clockwise/Counter-clockwise
	Force, individual specimens	10-50 N
	Force, specimen holder	30-300 N
Safety standards	See the Declaration of Conformity	
REACH	For information about REACH, contact your local Struers office.	
Noise level	See the noise level stated for: LaboPol	
Power supply	LaboForce-100 is connected directly to LaboPol	
Software and electronics	Controls	Touch pad, Turn/push knob knob
	Memory	FLASH-ROM/RAM/NV-RAM
	LC display	TFT-colour 320x240 dots with LED back light

Subject	Specifications	
Operating environment	Surrounding temperature	5 – 40°C/41 – 104°F
	Humidity	< 85 % RH non-condensing
Storage and transport conditions	Surrounding temperature	0 – 60°C/32 – 140°F
	Humidity	< 85 % RH non-condensing
Air supply	Air inlet	Diameter: 6 mm/1/4"
	Air pressure	6 - 9.9 bar/87 - 143 psi
	Air quality	Recommended quality: ISO 8573-1, class 5.6.4
Dimensions and weight	Width	20.3 cm/8"
	Depth	43.3 cm/17.0"
	Height	57.4 cm/22.6"
	Weight	20.5 kg/45.2 lbs

9.2 Diagrams - LaboForce-100

Title	No.
LaboForce-100, LaboDoser-100, Block diagram	16363050
LaboForce-100, Air diagram	16361000

16361000

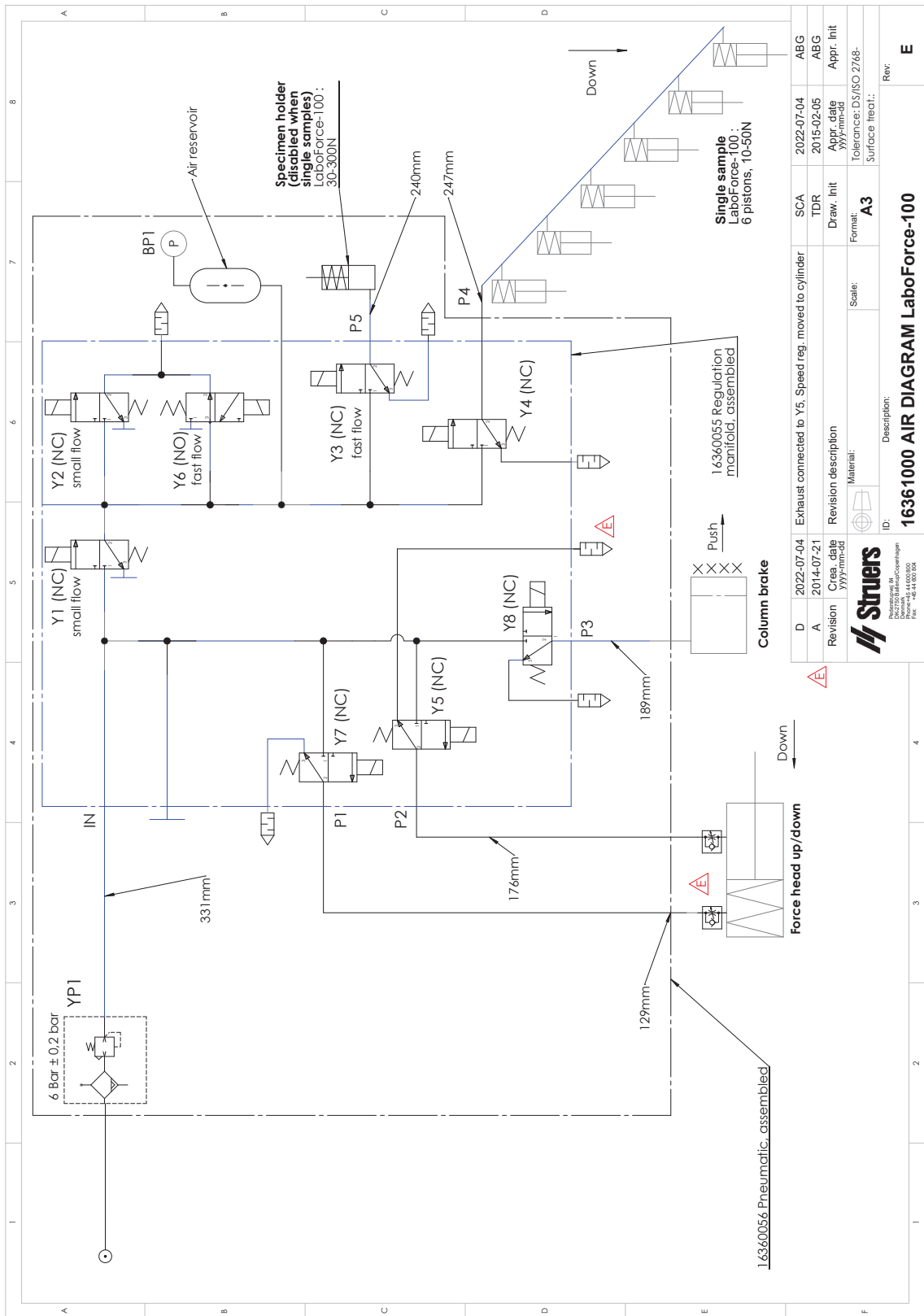

D	2022-07-04	Revision	Area	2014-07-21	Created	2014-07-21	Created	2014-07-21	Created	2014-07-21	Created	2014-07-21	Created
A	2014-07-21	Revision	Area	2014-07-21	Created	2014-07-21	Created	2014-07-21	Created	2014-07-21	Created	2014-07-21	Created
Exhaust connected to Y5. Speed reg. moved to cylinder													
Revision description													
Material:													
Scale:													
Format: A3													
Tolerance: DS/ISO 2768-													
Surface treat.:													
ID:													
Description:													
16361000 AIR DIAGRAM LaboForce-100													
SCA													
TDR													
Draw. Init													
Appr. date													
Appr. Init													
2022-07-04													
2015-02-05													
ABG													
ABG													
Rev:													
E													

9.3 Legal and regulatory information

FCC notice

This equipment has been tested and found to comply with the limits for a Class B digital device, pursuant to part 15 of the FCC Rules. These limits are designed to provide reasonable protection against harmful interference in a residential installation. This equipment generates, uses and can radiate radio frequency energy and, if not installed and used in accordance with the instructions, may cause harmful interference to radio communications. However, there is no guarantee that interference will not occur in a particular installation. If this equipment does cause harmful interference to radio or television reception, which can be determined by turning the equipment off and on, the user is encouraged to try to correct the interference by one or more of the following measures:

- Reorient or relocate the receiving antenna.
- Increase the separation between the equipment and receiver.
- Connect the equipment into an outlet on a circuit different from that to which the receiver is connected.

10 Manufacturer

Struers ApS
Pederstrupvej 84
DK-2750 Ballerup, Denmark
Telephone: +45 44 600 800
Fax: +45 44 600 801
www.struers.com

Responsibility of the manufacturer

The following restrictions should be observed, as violation of the restrictions may cause cancellation of Struers legal obligations.

The manufacturer assumes no responsibility for errors in the text and/or illustrations in this manual. The information in this manual is subject to change without notice. The manual may mention accessories or parts not included in the supplied version of the equipment.

The manufacturer is to be considered responsible for effects on safety, reliability, and performance of the equipment only if the equipment is used, serviced, and maintained in accordance with the instructions for use.

Declaration of Incorporation of Partly Completed Machinery

Manufacturer	Struers ApS • Pederstrupvej 84 • DK-2750 Ballerup • Denmark
Name	LaboForce-100
Model	N/A
Function	Specimen mover for LaboPol-30/LaboPol-60 (Grinding/Polishing machine)
Type	636
Cat. no.	06366127

The above listed machinery is only intended to be used with:

Struers machinery and consumables

And shall not be put into service until the final machinery into which it is to be incorporated has been declared in conformity with this regulation, where appropriate.

Serial no.



Module H, according to global approach



We declare that the product mentioned is in conformity with the following legislation, directives and standards:

2006/42/EC	EN ISO 12100:2010, EN ISO 13849-1:2015, EN ISO 13849-2:2012, EN 60204-1:2018, EN 60204-1-2018/Corr.:2020
2011/65/EU	EN 63000:2018
2014/30/EU	EN 61000-3-2:2014, EN 61000-3-3:2013, EN 61000-6-1:2007, EN 61000-6-3:2007, EN 61000-6-3-A1:2011, EN 61000-6-3-A1-AC:2012
Additional standards	NFPA 79, FCC 47 CFR Part 15 Subpart B

Authorized to compile technical file/
Authorized signatory

Date: [Release date]

en For translations see
bg За преводи вижте
cs Překlady viz
da Se oversættelser på
de Übersetzungen finden Sie unter
el Για μεταφράσεις, ανατρέξτε στη διεύθυνση
es Para ver las traducciones consulte
et Tõlked leiate aadressilt
fi Katso käännökset osoitteesta
fr Pour les traductions, voir
hr Za prijevode idite na
hu A fordítások itt érhetőek el
it Per le traduzioni consultare
ja 翻訳については、
lt Vertimai patalpinti
lv Tulkojumus skatīt
nl Voor vertalingen zie
no For oversættelser se
pl Aby znaleźć tłumaczenia, sprawdź
pt Consulte as traduções disponíveis em
ro Pentru traduceri, consultați
se För översättningar besök
sk Preklady sú dostupné na stránke
sl Za prevode si oglejte
tr Çeviriler için bkz
zh 翻译见

www.struers.com/Library