

RepliSet



Users guide and applications

RepliSet Users Guide

Description

RepliSet is a specially formulated fast curing two-part silicon rubber for flexible high-resolution replicas.

Safety Measures

Storage and Transportation

Store the cartridges horizontally and at room temperature. Temperature cycling between ambient and a low temperature may cause air to be drawn into the cartridge. Such cycling should be minimised.

Lifetime

RepliSet should be used before the expiry date to ensure optimal product properties. The expiry month and batch code are indicated on each cartridge.

Expired cartridges may still produce high-quality replicas, however Struers cannot guarantee for proper curing. If an expired compound cures normally, the copy (area of interest on the replica) will normally be OK.

Store opened cartridges with the nozzle on as a seal. An opened cartridge can be stored at room temperature for at least four weeks until it is used again.

Precautions

Do not attempt to press material into nozzles, which are blocked with cured material. Curing agent can be pushed into the compound causing curing of the material in the cartridge.

Standard

RepliSet is an accepted replicating system for ASTM standard E 1351.

Compatibility

The compounds contain minimal levels of fluorine, chlorine, sulphur compounds and heavy metals and are designed specifically to be compatible with stainless steels and other engineering alloys and not to compromise future corrosion behaviour should traces of replicas remain after replication.

Operating the 50 ml Dispensing System

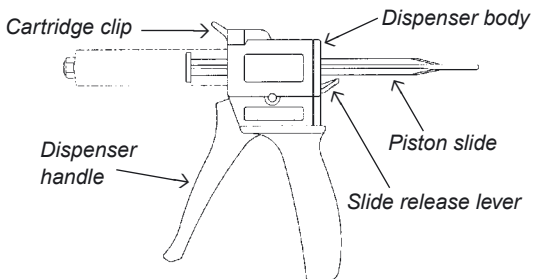

Assembly

- Fit the “spade” end of the piston slide into the handle side of the dispenser.
- Raise the slide release lever and push the slide back until the piston contact the dispenser body.
- Raise the cartridge clip and slide the cartridge into position with the appropriate pistons opposite each other. Lock the cartridge in position using the cartridge clip. Push the piston slide until it contacts the cartridge.
- Remove end cap from cartridge (twist counter-clockwise) and operate dispensing gun until compound issues from both cartridge ports. Wipe the end of the cartridge. Alternatively, discard the first 2-3 cm of compound coming out of the mixing nozzle.
- Attach a mixing nozzle to the cartridge. The nozzle will fit easily if it is oriented correctly. A quarter turn will secure the nozzle to the cartridge.

Use

- After use leave the mixing nozzle in place on the cartridge to act as a seal.
- Each time the flow of compound is stopped for a period longer than the working life (see cartridge) a new nozzle must be used.

Removal of Cartridge

- Push slide release lever and pull the piston slide to its back position. Lift the cartridge clip and remove the cartridge.

Cleaning of the Surface

The area to be examined should be clean and degreased. Use cotton wool and a solvent.

- Alcohol will normally be sufficient for metallographic applications.
- Engineering surfaces should be degreased using a suitable solvent like acetone.
- Make sure that the solvent has evaporated completely before application of the compound.

Note: RepliSet will not cure if residues of grease or solvents are left on the surface or retained in inclusions.

Selection of Compound

Surface facing	Temperature of surface	Working life	Recommended compound
Horizontal, sloping	> 20°C	Normal	RepliSet-F5
		Short	RepliSet-F1/GF1
	< 20°C	Normal	
Vertical, overhead	> 20°C	Normal	RepliSet-T3
		Short	RepliSet-T1/GT1
	< 20°C	Normal	

The process time varies with the temperature. Please see graph in the RepliSet Instruction Manual.

Choice of Colour

RepliSet-F or -T (black) should be used for microscopic examination by optical microscope with reflected light.

RepliSet-G (grey) should be used for macroscopic examination with oblique illumination.

All replicas are suitable for 3D examination by SEM and non-contact metrology methods such as interferometry, laser scanning and shadowgraph projection.

Application of Compound

- Turn the nozzle-end to point downwards and keep it touching, or as close to, the surface as possible to avoid trapping air in the replica and to force the material into surface features.
- Weave the nozzle end from side to side if a wider bead is required; each weave should overlap the previous one.
- At vertical surfaces, start applying the beads from the bottom.
- When filling holes, introduce nozzle in the hole and fill from the bottom. Lengthen nozzle with a nozzle tip or a piece of tube, if required.

Note: For correct results do not exceed the recommended working time (see cartridge).

Removing the Cured Replica

- Allow the RepliSet compound to cure, then carefully peel off the cured replica from one side.

Note: For correct results do not go under the recommended curing time (see cartridge). Checking the drop remaining on the nozzle will give an indication of the time required.

Replicas of Microstructures

- A good quality deep etching is important.
- Backing paper should always be used.
- Replicas should be made as thin and as flat as possible and should be mounted on glass slides using double-sided adhesive tape.

Mounting Backing Paper

- Mount backing paper immediately after application of the compound.
- Apply shiny side of backing paper to uncured replica. Position the backing paper to one side so that it can be folded over to protect the copy after curing.
- Apply light pressure to the backing paper using a flat stamp or small roller to produce a thin film replica and increase resolution.

Use of Backing Paper

Identification of the replica can be written directly on the back of the backing paper.

The backing paper serves as a handle when pulling replicas out from re-entrant geometries.

The backing paper allows the replica to be mounted on a glass slide by means of double adhesive tape.

The replica will have the original profile when mounted on a flat surface, when the backing paper has been pressed entirely flat.

Use of Spreader

The fishtail spreaders used as nozzle tips facilitate the application of the -T types of RepliSet and improve the resolution of the replica.

Re-entrant Geometries

RepliSet can be pulled out of moderately re-entrant geometries, e.g. bolt holes or cracks.

- Let RepliSet cure for at least twice the recommended curing time. Pull steadily and slowly when removing the replica.
- Leave the replica for at least 30 min. before measurement, in order to recover the precise shape.

Note: Increased curing time (up to one day) will increase the tensile strength.

Remote or Inaccessible Locations

RepliSet allows otherwise inaccessible surfaces to be examined.

- Use a slow curing, fluid type of RepliSet.
- Mount an extension tube on the nozzle.
- Leave the tube in contact with the replica until it is cured.
- Retrieve the replica and tube together.

Positive Replica

A positive replica of a 3D surface can be produced, making a replica of the original replica.

- Leave the first replica for at least one day, before the second replica is made.
- Strip the second replica as soon as it has cured.

Hard Replica

A hard positive replica of a 3D surface can be produced, making an epoxy replica of a RepliSet replica. A re-entrant surface can thus be replicated and measured using contacting equipment.

- Leave the RepliSet replica for at least one day, before the epoxy replica is made.
- Cast the second replica using Specifix-20. Vacuum impregnation is recommended.

Note: The geometry of the epoxy replica is influenced by the shrinkage of the epoxy system.

Humid Environments

RepliSet is water-repellent, and can provide replicas of humid surfaces with appropriate application techniques.

High Temperature Application

The compound has to be applied quickly and under pressure directly at the surface.

- Coat a strip of backing paper with RepliSet compound on the shiny side.
- Rapidly paste it on the surface, whilst pressing the compound against the surface.

Storage of Replicas

The life span of the replicas is practically indefinite provided they are stored properly and they are not pressed against other surfaces.

- Fold the backing paper to cover the copy and keep it in a closed plastic bag stored in a box or similar. Alternatively, store the replica in a tight box or similar in such a way that any contact with the copy is avoided.
- Never put the replica under pressure.
- Store at room temperature.

Note: Do not leave the surface of the copy in direct contact with plastic bag material.

Cleaning the Replica

Should the surface of the replica become contaminated by dust, it can easily be cleaned.

- Use adhesive tape. The dust adheres to the tape.
- Alternatively, wash with isopropyl alcohol.

Note: Solvents other than alcohol should not be used for cleaning the replica.

Optical Microscopy

The light intensity should be increased compared to when examining a metal sample directly.

Removal of filters from the light path is recommended, especially at high magnifications.

The use of polarized light and DIC at high magnifications increases both contrast and resolution.

Interferometry

Interferometry can be used for precise surface measurements including determination of surface finish.

SEM / Field Ion Microscopes

Uncoated 3D replicas may be examined directly by SEM using low kV (about 2 kV at high magnifications, it might be higher at low magnifications).

For coated replicas it is possible to work satisfactorily at 20 kV if this is required. The best magnification is $\times 2 - 3000$.

Note: SEM is not suitable for the examination of flat microstructure samples.

Coating the Replica

For high magnification SEM the replicas can be metal coated.

Take care that the replica does not become overheated.

A coating thickness of 100 Angstroms is recommended.

- Mount the replica on a glass slide or other solid surface before coating and examine the sample whilst it is still mounted.

Note: The coating will crack, if the replica is not supported adequately.

Laser Measuring Instruments

Laser measuring equipment, having a typical resolution of $0.1 \mu\text{m}$, is very well suited.

Measuring Projectors

Measuring projectors with 2D or 3D facilities are very well suited.

Shadow graph is well suited for examination of the replica of a cavity.

Macroscopy

The light should be almost parallel to the surface.

Contacting Equipment

Note: As the replica is resilient, examination by contacting equipment cannot be recommended.

Please see application examples and Materials Safety Data Sheet at www.struers.com

For more detailed information on the RepliSet system, please ask your Struers distributor to supply the comprehensive RepliSet Instruction Manual as a pdf file.



RepliSet applications

The use of high-resolution replicas allows otherwise inaccessible surfaces, and irregularities in critical machinery in service to be examined and measured under laboratory conditions.

Make a replica in the field

- non-destructive
- under all weather conditions

Bring the replica to the lab

- your own laboratory /
- a specialist laboratory

Explore all the details in the microscope

- details down to 0.1 μm
- dimensionally accurate



*See more application
examples at
www.struers.com*

Technical Data

Resolution of cured replica:	Down to 0.1 micron
Shrinkage:	Negligible
Tear strength:	15-20 kN/m ²
Temperature range for the surface to be examined:	-10°C to +180°C
Life span of the finished replicas is practically indefinite provided they are stored according to the instructions	
Content in static-mixing nozzle:	1.1 ml in nozzle for 50 ml cartridge 9.3 ml in nozzle for 265 ml cartridge

Technische Daten

Auflösung des ausgehärteten Abdrucks:	Bis zu 0,1 Mikrometer
Schrumpfung:	Vernachlässigbar
Reissfestigkeit:	15-20 kN/m ²
Temperaturbereich der untersuchbaren Oberfläche:	-10°C bis +180°C
Die Lebensdauer der fertigen Abdrücke ist praktisch unbegrenzt wenn sie den Anleitungen gemäss aufbewahrt werden.	
Inhalt der statischen Mischdüse:	1,1 ml in Düse mit 50 ml Kartusche 9,3 ml in Düse mit 265 ml Kartusche

Données techniques

Résolution de la réplique durcie:	Jusqu'à 0,1 micron
Rétrécissement:	Négligeable
Résistance à la déchirure:	15-20 kN/m ²
Plage de température de la surface à examiner:	De -10°C à +180°C
La durée de vie des répliques finies est pratiquement sans limite, à condition que celles-ci soient conservées selon les instructions	
Contenu de la buse de mélange statique:	1,1 ml dans la buse pour la cartouche de 50 ml. 9,3 ml dans la buse pour la cartouche de 265 ml.

Corrosion / Korrosion / Corrosion



Photo

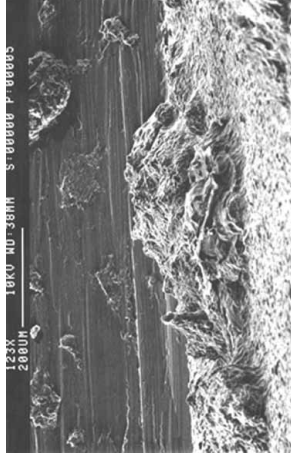

SEM

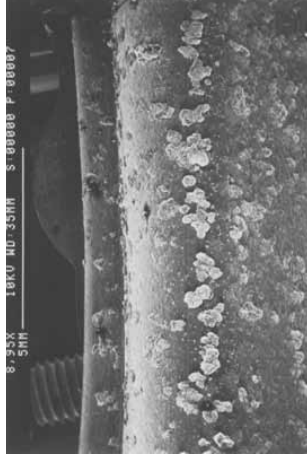

SEM

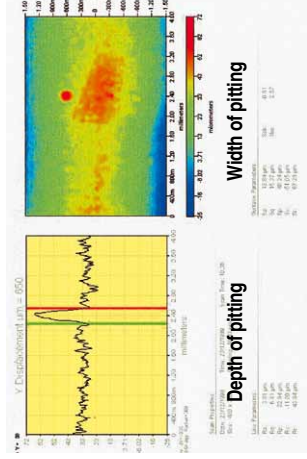

Laser metrology

Cracking / Risse / Fissures

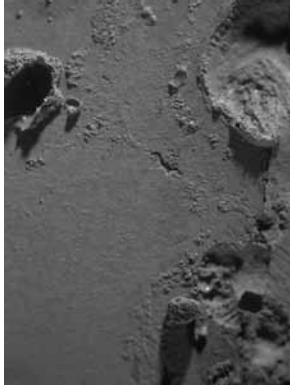

Stereo macroscopy

Fracture / Bruchflächen / Rupture

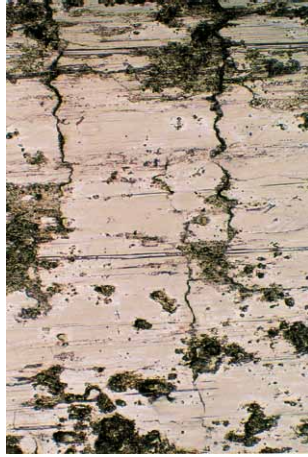
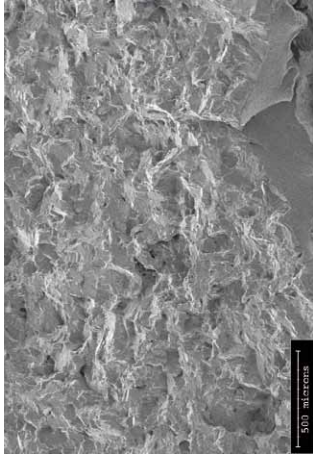

Optical microscopy

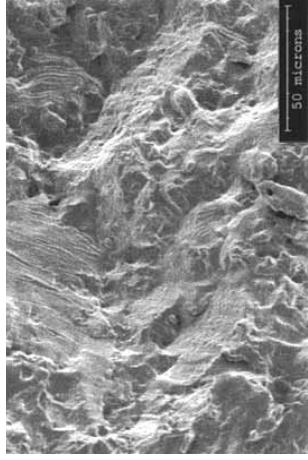

SEM

Surface damage / Oberflächenschäden / Dommage surface



Optical microscopy

Roughness / Rauhnigkeit / Rugosité

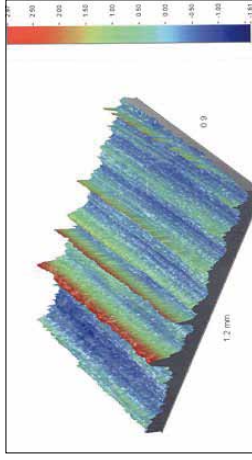

Interferometry

Profile / Profil / Profil

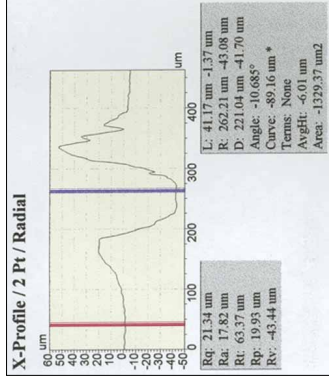

Laser metrology

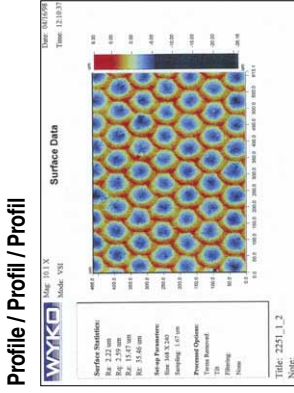

Laser metrology

Wear / Verschleiß / Usure

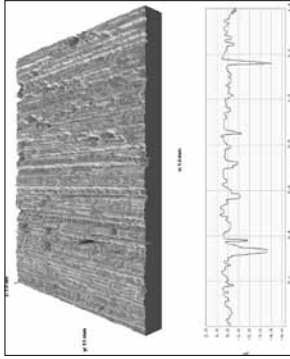

Interferometry

Threads / Gewinde / Filets



Photo

Cavities / Hohlräume / Cavités



Photo

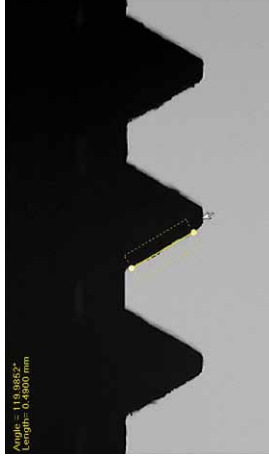

Laser metrology

Tool marks / Werkzeugspuren / Marques d'outil

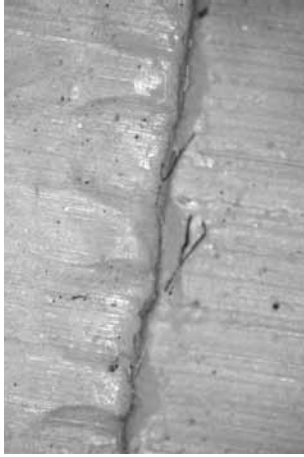

Stereo macroscopy

Microstructure / Microgefüge / Microstructure



100 : 1

100µm

- 1: Replica of tool marks
- 2: Tool marks in lead

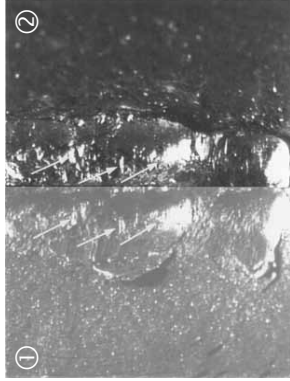

Comparator macroscopy

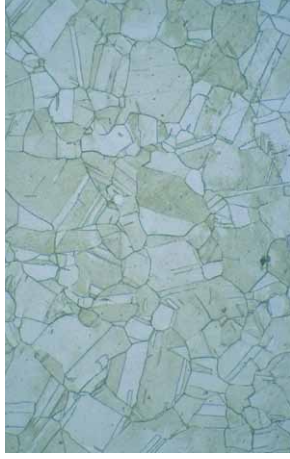

Optical microscopy



Struers A/S

Pederstrupvej 84

DK-2750 Ballerup,

Denmark

Phone +45 44 600 800

Fax +45 44 600 801

struers@struers.dk

www.struers.com

RepliFix-2

#50900065
23.04.2013

Instructions for Use

- EN:** Safety data sheet available for professional user on request.
- DE:** Sicherheitsdatenblatt auf Anfrage für berufsmäßige Verwender erhältlich.
- FR:** Fiche de données de sécurité disponible sur demande pour les professionnels.
- IT:** Scheda dati di sicurezza disponibile su richiesta per gli utilizzatori professionali.
- ES:** Ficha de datos de seguridad a la disposición del usuario profesional que la solicite.
- PT:** Ficha de segurança fornecida a pedido de utilizadores profissionais.
- DK:** Leverandørbrugsanvisning kan rekvireres af erhvervsmæssige brugere.
- SE:** Säkerhetsdatablad finns att tillgå för yrkesmässiga användare och tillhandahålls på begäran.
- NO:** Sikkerhetsdatablad er tilgjengelig på anmodning fra yrkesmessige brukere.
- FI:** Käyttöturvallisuustiedote toimitetaan ammattikäyttäjälle pyynnöstä.
- NL:** Inlichtingenblad aangaande de veiligheid is voor de professionele gebruiker op aanvraag verkrijgbaar.
- PL:** Karta charakterystyki dostępna na żądanie użytkownika prowadzącego działalność zawodową.
- CZ:** Pro profesionální uživatele je na požádání k dispozici bezpečnostní list.
- HU:** Biztonsági adatlap foglalkozásszerű felhasználók kérésére rendelkezésre áll.
- RO:** Fiș a Tehnică de Securitate disponibilă la cerere pentru utilizatorii profesionali.
- BG:** Информационният лист за безопасност е на разположение на професионалния потребител при поискване .
- CN:** 专业用户可根据需求索取材料安全数据表。
- JP:** 必要な場合に安全データシートを提供する用意があります。

RepliFix-2

Specially formulated fast curing 2-component silicone rubber. To be mixed manually; bonds with RepliSet. Particularly useful in combination with RepliSet for producing a rigid backing. It can be used directly for moulding of surface shape for profile measurement. For low temperature conditions or where rapid results are required.

Instructions

Contents of Packing

- 1 RepliFix-2 Yellow (250g)
- 1 RepliFix-2 Blue (250g)
- 1 Pair of gloves
- 1 User's Manual

Mixing

- Make sure that the surface is clean and degreased.
- Measure equal amounts of RepliFix-2, Yellow and RepliFix-2, Blue (measure by eye).
- Mix by hand (use protective gloves), until the compound is of a uniform color.
- Form and apply the mixed compound by hand.
- Allow the compound to cure.

Working life

2 - 3 min. at 25 °C

Curing time

10 min. at 25 °C

Safety data sheet available for professional user on request.

RepliFix-20

#50900064
23.04.2013

Instructions for Use

- EN:** Safety data sheet available for professional user on request.
- DE:** Sicherheitsdatenblatt auf Anfrage für berufsmäßige Verwender erhältlich.
- FR:** Fiche de données de sécurité disponible sur demande pour les professionnels.
- IT:** Scheda dati di sicurezza disponibile su richiesta per gli utilizzatori professionali.
- ES:** Ficha de datos de seguridad a la disposición del usuario profesional que la solicite.
- PT:** Ficha de segurança fornecida a pedido de utilizadores profissionais.
- DK:** Leverandørbrugsanvisning kan rekvireres af erhvervsmæssige brugere.
- SE:** Säkerhetsdatablad finns att tillgå för yrkesmässiga användare och tillhandahålls på begäran.
- NO:** Sikkerhetsdatablad er tilgjengelig på anmodning fra yrkesmessige brukere.
- FI:** Käyttöturvallisuustiedote toimitetaan ammattikäyttäjälle pyynnöstä.
- NL:** Inlichtingenblad aangaande de veiligheid is voor de professionele gebruiker op aanvraag verkrijgbaar.
- PL:** Karta charakterystyki dostępna na żądanie użytkownika prowadzącego działalność zawodową.
- CZ:** Pro profesionální uživatele je na požádání k dispozici bezpečnostní list.
- HU:** Biztonsági adatlap foglalkozásszerű felhasználók kérésére rendelkezésre áll.
- RO:** Fiș a Tehnică de Securitate disponibilă la cerere pentru utilizatorii profesionali.
- BG:** Информационният лист за безопасност е на разположение на професионалния потребител при поискване .
- CN:** 专业用户可根据需求索取材料安全数据表。
- JP:** 必要な場合に安全データシートを提供する用意があります。

RepliFix-20

Specially formulated fast curing 2-component silicone rubber. To be mixed manually; bonds with RepliSet. Particularly useful in combination with RepliSet for producing a rigid backing. It can be used directly for moulding of surface shape for profile measurement. For low temperature conditions or where rapid results are required.

Instructions

Contents of Packing

- 1 RepliFix-20 Yellow (250g)
- 1 RepliFix-20 Blue (250g)
- 1 Pair of gloves
- 1 User's Manual

Mixing

- Check that the surface is clean and degreased.
- Measure equal amounts of RepliFix-20 Yellow and RepliFix-20 Blue (measure by eye).
- Mix by hand (use protective gloves), until the compound is of a uniform color.
- Form and apply the mixed compound by hand.
- Allow the compound to cure.

Working life

20 min. at 25 °C

Curing time

60 min. at 25 °C

Safety data sheet available for professional user on request.

RepliSet

Users Guide Gebrauchsanweisung Guide de l'utilisateur

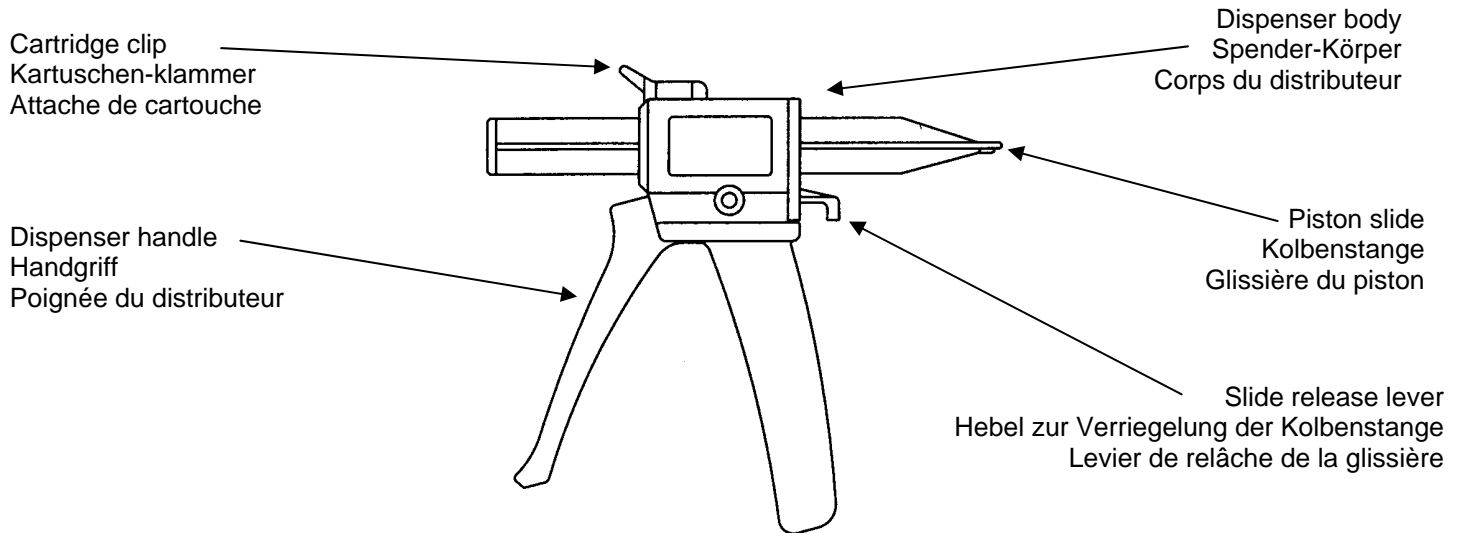

Operating the 50 ml dispensing system

1. Fit the "spade" end of the piston slide into the handle side of the dispenser. Raise the slide release lever and push the slide back until the piston contact the dispenser body.
2. Raise the clip on the top of the dispenser and slide the cartridge vertically into position on the front of the dispenser with the appropriate pistons opposite each other. Lock the cartridge in position using the clip on top of the dispenser.
3. Remove end cap from cartridge (twist counter-clockwise) and operate dispensing gun until compound issues from both cartridge ports. Wipe the end of the cartridge.
4. Attach a mixing nozzle to the cartridge. The nozzle is moulded with a notch, which must be aligned with the ridge on the cartridge for correct fitting. The nozzle will fit easily if it is oriented correctly. A quarter turn will secure the nozzle to the cartridge. If difficulty is experienced the nozzle should be rotated 180 degrees.
5. Operate the dispenser smoothly to apply the RepliSet compound. Point the nozzle downwards and keep it touching or as close to the surface as possible to avoid trapping air in the replica and to force the material into surface features. Overlap runs to cover larger areas. Weave the nozzle end from side to side if a wider bead is required but each weave should overlap the previous one. At vertical surfaces the beads should be placed from the bottom.
6. Do not apply excessive hand pressure to the dispenser as this may damage the operating mechanism.
7. After use it is advisable to leave the mixing nozzle in place on the cartridge to act as a seal until the cartridge is used again. The used nozzle will also extract any cured material from the cartridge ports as it is removed.
8. Allow the RepliSet compound to cure (check the cartridge for curing time), and then carefully peel off the cured replica from one side. To prevent damage and loss of the recorded detail, do not touch the replica surface and store the replica in a plastic bag.
9. Each time the flow of compound is stopped for a period longer than the working life a new nozzle must be used.
10. Push slide release lever and pull the piston slide to its back position. Lift the cartridge clip and remove the cartridge.

NOTE

The process time for RepliSet varies with the temperature. Please see detailed information in Instruction Manual. For correct results do not go beyond the actual working time and do not go under the actual curing time.

For more detailed information on the RepliSet system, please refer to the RepliSet Reference Guide www.struers.com/manuals.

Bedienung des 50 ml Spenders

1. Führen Sie das "spatenförmige" Ende der Kolbenstange auf der Handgriffseite in den Spender ein. Heben Sie die Verriegelung an und schieben Sie die Stange so weit zurück, bis der Kolben den Körper des Spenders berührt.
2. Heben Sie die Klammer auf der Oberseite des Spenders an, und schieben Sie die Kartusche in vertikaler Position auf der Vorderseite des Spenders so ein, dass die entsprechenden Kolben sich gegenüberstehen. Arretieren Sie die Kartusche mit dem oberliegenden Verriegelungshebel.
3. Entfernen Sie die Schutzkappe von der Kartusche (drehen im Gegenuhrzeigersinn) und betätigen Sie den Spender so lange, bis Masse aus beiden Kartuschenöffnungen austritt. Wischen Sie die Enden der Kartusche ab.
4. Bringen Sie eine Mischdüse an der Kartusche an. Die Düse ist mit einer Kerbe versehen. Damit die Düse richtig sitzt, muss diese Kerbe mit dem Oberrand der Kartusche in Deckung gebracht werden. Wenn die Ausrichtung stimmt, lässt die Düse sich leicht anbringen. Mit einer Vierteldrehung sichern Sie die Düse auf der Kartusche. Sollten Probleme auftreten, rotieren Sie die Kartusche um 180 Grad.
5. Bedienen Sie den Spender beim Anwenden der RepliSet-Masse möglichst gleichmäßig. Drehen Sie die Düsen spitze so dass sie nach unten zeigt, und die Oberfläche berührt oder so nah wie möglich an dieser bleibt, damit Lufteinschlüsse im Abdruck vermieden werden und die Masse in die Oberflächentopografie eingedrückt wird. Beim Abdecken großer Flächen sollten sich die einzelnen Bahnen überdecken. Falls ein breiteres Bett erforderlich ist, führen Sie die Düse in einem Schlangenmuster hin und her, wobei sich auch hier die einzelnen Stränge überlappen sollten. Beginnen Sie die Abdeckung senkrechter Flächen von unten her.
6. Wenden Sie bei der Bedienung des Spenders nicht übermäßig Kraft an, weil dies die Mechanik beschädigen kann.
7. Nach der Anwendung sollte die Mischdüse als Deckel auf der Kartusche verbleiben, so dass die Masse bis zur nächsten Anwendung versiegelt ist. Durch das Abnehmen der benutzten Düse wird ausgehärtetes Material von den Austrittsöffnungen der Kartusche entfernt.
8. Halten Sie die Aushärtzeit der RepliSet-Masse ein (steht auf der Kartusche) und ziehen Sie den ausgehärteten Abdruck vorsichtig von einer Seite her ab. Berühren Sie die Oberfläche des Abdrucks nicht, damit erfasste Details nicht beschädigt werden oder verlorengehen. Bewahren Sie den Abdruck in einer Plastiktüte auf.
9. Falls der Massefluss länger als die vorgesehene Verarbeitungszeit unterbrochen wird, muss eine neue Düse verwendet werden.
10. Drücken Sie den Verriegelungshebel und ziehen Sie die Kolbenstange bis zum Anschlag zurück. Heben Sie die Kartuschenklammer an und entfernen Sie die Kartusche.

HINWEIS

Die Prozesszeit von RepliSet ist temperaturabhängig. Bitte sehen Sie die detaillierten Anweisungen in der Gebrauchsanweisung. Für richtige Ergebnisse darf die Verarbeitungszeit nicht überschritten und die Aushärtzeit nicht unterschritten werden.

Falls Sie weitere Einzelheiten über das RepliSet-System wissen wollen, Bitte sehen Sie die Referenzhandbuch, von www.struers.com/manuals.

Fonctionnement du distributeur 50 ml

1. Mettre l'extrémité en forme de "bêche" de la glissière du piston dans le côté de la poignée du distributeur. Soulever le levier de relâche de la glissière et repousser la glissière jusqu'à ce que le piston rentre en contact avec le corps du distributeur.
2. Soulever l'attache sur le haut du distributeur et faire glisser la cartouche verticalement en bonne position sur le devant du distributeur avec les pistons adéquats bien en face l'un de l'autre. Bloquer alors la cartouche en position à l'aide de l'attache se trouvant sur le haut du distributeur.
3. Retirer le bouchon à l'extrémité de la cartouche (dévisser dans le sens inverse des aiguilles d'une montre) et manoeuvrer le pistolet distributeur jusqu'à ce que la masse sorte des orifices de la cartouche. Essuyer l'extrémité de la cartouche.
4. Rattacher une buse de mélange à la cartouche. La buse a été formée avec une encoche, qui doit être alignée sur le bord de la cartouche pour être placée correctement. La buse se place facilement si elle est bien orientée. Un quart de tour suffit pour fixer la buse à la cartouche. En cas de difficultés, faire faire à la buse une rotation de 180 degrés.
5. Utiliser le distributeur avec précaution pour appliquer la masse RepliSet. Faire pointer la buse vers le bas et la maintenir en contact ou aussi près de la surface que possible afin d'éviter les bulles d'air dans l'empreinte et de forcer le matériau dans les replis de la surface.
- Un chevauchement permettra de recouvrir les surfaces plus grandes. Tortiller l'extrémité de la buse d'un côté à l'autre si une charge de masse plus importante est nécessaire mais chaque charge devra chevaucher la précédente. Pour les surfaces verticales, les charges devront être placées en partant du bas.
6. Ne pas appliquer une pression manuelle excessive sur le distributeur car cela pourrait endommager le mécanisme de fonctionnement.
7. Après utilisation, il est conseillé de laisser la buse de mélange en place sur la cartouche pour qu'elle serve de bouchon jusqu'à la réutilisation de la cartouche. La buse utilisée permettra aussi d'extraire tout matériau durci des orifices de la cartouche quand elle sera retirée.
8. Laisser durcir la masse RepliSet (vérifier le temps de durcissement sur la cartouche), puis détacher l'empreinte durcie avec précaution en tirant d'un côté. Pour éviter l'endommagement et la perte des détails enregistrés, ne pas toucher la surface de l'empreinte et conserver celle-ci enfermée dans un sac plastique.
9. A chaque fois que la masse dosée est stoppée dans la buse pendant une période plus longue que sa durée de vie, il est nécessaire de changer la buse.
10. Pousser le levier de relâche de la glissière et tirer sur la glissière du piston pour la remettre en position arrière. Soulever l'attache de la cartouche et retirer la cartouche.

NOTER

Le temps de processus de RepliSet varie selon la température. Se reporter aux informations détaillées dans le Mode d'emploi. Pour obtenir des résultats corrects, il est important d'atteindre le temps de travail réel précis, sans toutefois le dépasser.

Pour des informations plus détaillées sur le système RepliSet, veuillez commander le Mode d'emploi, sur www.struers.com/manuals.

RepliSet

Users Guide Gebrauchsanweisung Guide de l'utilisateur

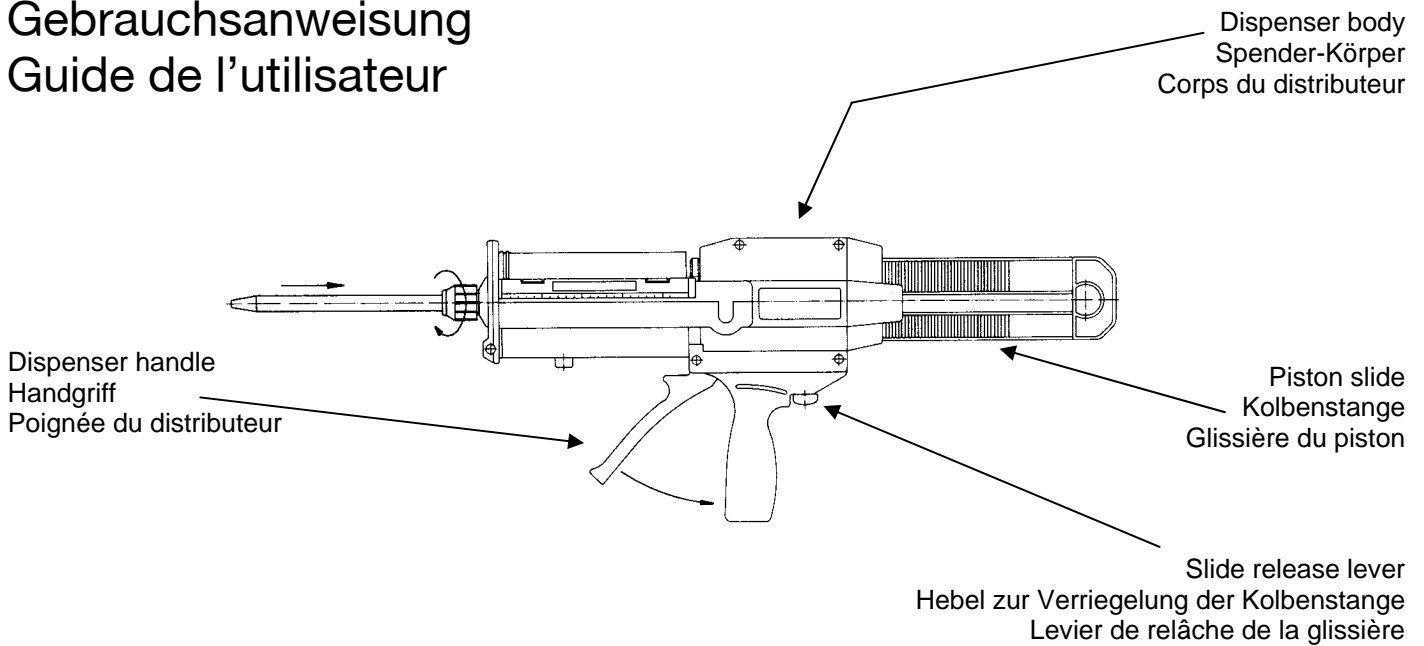

Operating the 265 ml dispensing system

1. Push the slide release button and push the slide back until the piston is in contact with the dispenser body.
2. Slide the cartridge vertically into position on the front of the dispenser with the appropriate pistons opposite each other.
3. Remove nozzle nut from cartridge (twist counter-clockwise). Attach mixing nozzle to the cartridge by aligning notch on nozzle with cartridge lug. Remove plug from nozzle nut and attach nut. Screw tightly.
4. Operate dispensing gun until compound issues. When using a new cartridge discard the first 5 ml issuing from the nozzle.
5. Operate the dispenser smoothly to apply the RepliSet compound. Point the nozzle downwards and keep it touching or as close to the surface as possible to avoid trapping air in the replica and to force the material into surface features. Overlap runs to cover larger areas. Weave the nozzle end from side to side if a wider bead
6. is required but each weave should overlap the previous one. At vertical surfaces the beads should be placed from the bottom.
6. Do not apply excessive hand pressure to the dispenser as this may damage the operating mechanism.
7. After use it is advisable to leave the mixing nozzle in place on the cartridge to act as a seal until the cartridge is used again. The used nozzle will also extract any cured material from the cartridge ports as it is removed.
8. Allow the RepliSet compound to cure (check the cartridge for curing time), and then carefully peel off the cured replica from one side. To prevent damage and loss of the recorded detail, do not touch the replica surface and store the replica in a plastic bag.
9. Each time the flow of compound is stopped for a period longer than the working life a new nozzle must be used.
10. Push slide release lever and pull the piston slide to its back position. Lift the cartridge.

NOTE

The process time for RepliSet varies with the temperature. Please see detailed information in Instruction Manual. For correct results do not go beyond the actual working time and do not go under the actual curing time.

For more detailed information on the RepliSet system, please refer to the RepliSet Reference Guide www.struers.com/manuals.

Bedienung des 265 ml Spenders

1. Drücken Sie den Hebel zur Verriegelung der Kolbenstange und schieben Sie die Stange so weit zurück, bis der Kolben den Körper des Spenders berührt.
2. Schieben Sie die Kartusche in vertikaler Position auf der Vorderseite des Spenders so ein, dass die entsprechenden Kolben sich gegenüberstehen.
3. Entfernen Sie die Überwurfmutter von der Kartusche (drehen Sie gegen den Uhrzeigersinn). Befestigen Sie die Mischdüse an der Kartusche durch das Ausrichten der Kerbe an der Düse mit dem Zapfen an der Kartusche. Entfernen Sie den Pfropfen von der Überwurfmutter und schrauben Sie die Mutter wieder auf die Kartusche. Ziehen Sie die Mutter gut an.
4. Betätigen Sie den Spender so lange, bis Masse aus austritt. Wenn Sie eine neue Kartusche benutzen, werfen Sie die zuerst aus der Düse ausgetretenen 5 ml weg.
5. Bedienen Sie den Spender beim Anwenden der RepliSet-Masse möglichst gleichmäßig. Drehen Sie die Düsenspitze so dass sie nach unten zeigt, und die Oberfläche berührt oder so nah wie möglich an dieser bleibt, damit Lufteinschlüsse im Abdruck vermieden werden und die Masse in die Oberflächentopografie eingedrückt wird. Beim Abdecken großer Flächen sollten sich die einzelnen Bahnen überdecken. Falls ein breiteres Bett erforderlich ist, führen Sie die Düse in einem Schlangenmuster hin und her, wobei sich auch hier die einzelnen Stränge überlappen sollten. Beginnen Sie die Abdeckung senkrechter Flächen von unten her.
6. Wenden Sie bei der Bedienung des Spenders nicht übermäßig Kraft an, weil dies die Mechanik beschädigen kann.
7. Nach der Anwendung sollte die Mischdüse als Deckel auf der Kartusche verbleiben, so dass die Masse bis zur nächsten Anwendung versiegelt ist. Durch das Abnehmen der benutzten Düse wird ausgehärtetes Material von den Austrittsöffnungen der Kartusche entfernt.
8. Halten Sie die Aushärtzeit der RepliSet-Masse ein (steht auf der Kartusche) und ziehen Sie den ausgehärteten Abdruck vorsichtig von einer Seite her ab. Berühren Sie die Oberfläche des Abdrucks nicht, damit erfasste Details nicht beschädigt werden oder verlorengehen. Bewahren Sie den Abdruck in einer Plastiktüte auf.
9. Falls der Massefluss länger als die vorgesehene Verarbeitungszeit unterbrochen wird, muss eine neue Düse verwendet werden.
10. Drücken Sie den Verriegelungshebel und ziehen Sie die Kolbenstange bis zum Anschlag zurück. Heben Sie die Kartuschenklammer an und entfernen Sie die Kartusche.

HINWEIS

Die Prozesszeit von RepliSet ist temperaturabhängig. Bitte sehen Sie die detaillierten Anweisungen in der Gebrauchsanweisung. Für richtige Ergebnisse darf die Verarbeitungszeit nicht überschritten und die Aushärtezeit nicht unterschritten werden.

Falls Sie weitere Einzelheiten über das RepliSet-System wissen wollen, Bitte sehen Sie die Referenzhandbuch, von www.struers.com/manuals.

Fonctionnement du distributeur 265 ml

1. Appuyer sur le bouton de relâche de la glissière et repousser la glissière vers l'arrière jusqu'à ce que le piston rentre en contact avec le corps du distributeur.
2. Faire glisser la cartouche verticalement en bonne position sur le devant du distributeur avec les pistons adéquats bien en face l'un de l'autre. Bloquer alors la cartouche en position à l'aide de l'attache se trouvant sur le haut du distributeur.
3. Retirer l'écrou de la buse de la cartouche (tourner dans le sens inverse des aiguilles d'une montre). Attacher la buse de mélange à la cartouche en alignant l'encoche sur la buse avec le bord de la cartouche. Retirer la prise de l'écrou de la buse et attacher l'écrou. Serrer fermement.
4. Faire fonctionner le pistolet distributeur jusqu'à ce que la masse en sorte. Lors de l'utilisation d'une cartouche neuve, jeter les premiers 5 ml sortant de la buse.
5. Utiliser le distributeur avec précaution pour appliquer la masse RepliSet. Faire pointer la buse vers le bas et la maintenir en contact ou aussi près de la surface que possible afin d'éviter les bulles d'air dans l'empreinte et de forcer le matériau dans les replis de la surface. Un chevauchement permettra de recouvrir les surfaces plus grandes. Tortiller l'extrémité de la buse d'un côté à l'autre si une charge de masse plus importante est nécessaire, mais chaque charge devra chevaucher la précédente. Pour les surfaces verticales, les charges devront être placées en partant du bas.
6. Ne pas appliquer une pression manuelle excessive sur le distributeur car cela pourrait endommager le mécanisme de fonctionnement.
7. Après utilisation, il est conseillé de laisser la buse de mélange en place sur la cartouche pour qu'elle serve de bouchon jusqu'à la réutilisation de la cartouche. La buse utilisée permettra aussi d'extraire tout matériau durci des orifices de la cartouche quand elle sera retirée.
8. Laisser durcir la masse RepliSet (vérifier le temps de durcissement sur la cartouche), puis détacher l'empreinte durcie avec précaution en tirant d'un côté. Pour éviter l'endommagement et la perte des détails enregistrés, ne pas toucher la surface de l'empreinte et conserver celle-ci enfermée dans un sac plastique.
9. A chaque fois que la masse dosée est stoppée dans la buse pendant une période plus longue que sa durée de vie, il est nécessaire de changer la buse.
10. Pousser le levier de relâche de la glissière et tirer sur la glissière du piston pour la remettre en position arrière. Soulever l'attache de la cartouche et retirer la cartouche.

NOTER

Le temps de processus de RepliSet varie selon la température. Se reporter aux informations détaillées dans le Mode d'emploi. Pour obtenir des résultats corrects, il est important d'atteindre le temps de travail réel précis, sans toutefois le dépasser.

Pour des informations plus détaillées sur le système RepliSet, veuillez commander le Mode d'emploi, sur www.struers.com/manuals.



Pederstrupvej 84
DK-2750 Ballerup
Denmark